

FIG. 1

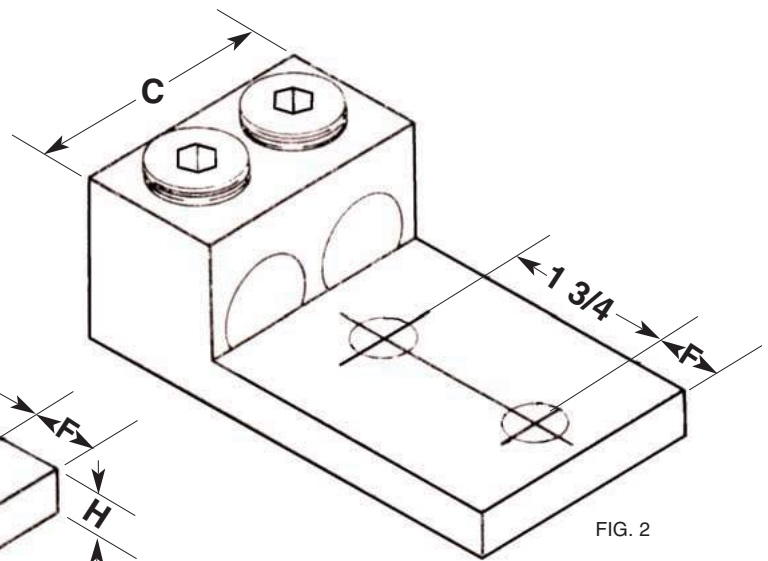

FIG. 2

CAT. NO.	FIG.	WIRE RANGE CU9AL	A	B	C	D	E	F	H
350L2	1	350 MCM-6	4.312	1.375	1.125	0.562	1.312	0.625	0.312